

Edition February 2022

OBSTAFLASH Led integrated 48VDC & 100-240VAC L-865/L-864



INSTALLATION AND OPERATION GUIDE

List of models

Designation		Type and Color	Input voltage	P/N
OFI360-RW-48-U		L-865/L-864 dual color medium intensity type A/B	48VDC +15%/-5%	113792U
OFI360-WW-48-U		L-865 white medium intensity type A	48VDC +15%/-5%	113791U
OFI360-R-48		L-864 red medium intensity type B	48VDC +15%/-5%	113790U
OFI360-RW-240-U (OFI360-RW-48-U + OFI-CAB-1E-RW-240-U P/N113797U)		L-865/L-864 dual color medium intensity	110-230VAC +/-10%	113725UI
OFI360-WW-240-U (OFI360-WW-48-U + OFI-CAB-1E-RW-240-U P/N113797U)		L-865 white medium intensity	110-230VAC +/-10%	113723UI
OFI360-R-240-U (OFI360-R-48 + OFI-CAB-1E-R-240 P/N113795)		L-864 red medium intensity	110-230VAC +/-10%	113724I

In option:

- wireless GPS P/N113746IV2 (inside flash-head).
- 110VAC-230VAC side lights L-810(F) NAVILITE FAA P/N113969IR

BE CAREFUL!

Led projectors in this lighting system produce brilliant flashes of light which can result in temporary or permanent eye damage. **DO NOT LOOK DIRECTLY AT THEM WHILE IT IS IN OPERATION.**

WARRANTY

OBSTA warrants the equipment described in the instruction manual and sold to purchaser to be free from defects in material and workmanship at the time of shipment. OBSTA's liability under this warranty being limited to repairing or replacing, at OBSTA's option, items which are returned to it prepaid within twenty four (24) months from shipment to the original Purchaser, or twelve months from commissioning, and found, to OBSTA's satisfaction, to have been defective. In no event shall OBSTA be liable for consequential damages. **NO PRODUCT IS WARRANTED AS BEING FIT FOR A PARTICULAR PURPOSE AND THERE IS NO WARRANTY OF MERCHANTABILITY.** This warranty applies only if: (I) the items are used solely under the operating conditions and in the manner recommended in OBSTA's instruction manual, specifications, or other literature; (II) the items have not been misused or abused in any manner or repairs attempted thereon; (III) written notice of the failure within the warranty period is forwarded to OBSTA and the directions received for properly identifying items returned under warranty are followed; and (IV) such return notice authorizes OBSTA to examine and disassemble returned products to the extent OBSTA deems necessary to ascertain the cause of failure. The warranties stated herein are exclusive. **THERE ARE NO OTHER WARRANTIES, EITHER EXPRESSED OR IMPLIED, BEYOND THOSE SET FORTH HEREIN,** and OBSTA does not assume, nor does OBSTA authorize anyone else to assume for it, any other obligation or liability in connection with the sale or use of said products. OBSTA's liability on any claim of any kind, including negligence, for loss or damages arising out of or connected with the manufacture, sale, delivery, repair or use of any equipment or services provided by OBSTA shall in no case exceed the price allocable to the item or service or part thereof which gives rise to the claim.

The integrity and reliability of OBSTA aviation obstruction lighting systems is dependent on the use of OBSTA parts and components. To ensure the optimum performance and reliability of your OBSTA system, it is strongly advised that only components and modules manufactured by OBSTA be used.

Section 1: General information

1.1 Scope

This manual provides information about the installation, operation, and maintenance of the OBSTAFLASH LED Medium Intensity Obstruction Lighting Systems manufactured by OBSTA. The lighting systems described in this manual are Medium intensity type A/B and FAA type L-865/L-864 obstruction lights

1.2 General description

The OBSTAFLASH Lighting System is an LED medium intensity system manufactured to comply with ICAO annex 14 chapter 6 and Federal Aviation Administration Advisory Circular 150/5345-43J. Each system consists of one flash-head, and can be associated with power supply with ambient light sensor (photocell) and the interconnecting cable. System components are shown in Figures 1-1 to 1-4

1.2.1 OBSTAFLASH 48Vdc

The OBSTAFLASH 48Vdc consists of a flash-head with 6 led projectors made in glass and aluminum, a stainless power supply inside and an aluminum cover. Each projector includes 2 white LED circuits working in active redundancy (for L-865/L-864 and L-865) and one red LED circuit in serial with 2 other projectors. Each projector is provided with a molded cable connected to the stainless power supply that contains:

- 6 power cards for the 12 white led circuits (only for L-865/L-864 and L-865) + 1 power card for the 2 red led circuits
- a command card with 10 luminous indicators and 8 dipswitchs used for the setting of the system
- a test button to force day mode or night mode
- a 48Vdc surge protection
- a terminal connection for the 48Vdc input power, day/night information (0V=day mode, +48Vdc=night mode), alarm and optional external top sync (24V-to-48V pulse) coming from other light or gps interface for the synchronization with other lights

1.2.2 OBSTAFLASH 110-230VAC

The OBSTAFLASH 110-230VAC consists of a 48VDC flash-head (as above) and a 110-230VAC stainless power supply remotely located (up to 500ft - 150m from the flash-head) that contains:

- 2 power supplies, surge protection
- terminal blocks for wiring to the flash-head, external photocell, remote alarms, etc...
- A S2 button with 3 positions
- "Remote" position, the lights are in normal operation
- "Day" position, the light is forced in day mode
- "Night" position, the light is forced in night mode.

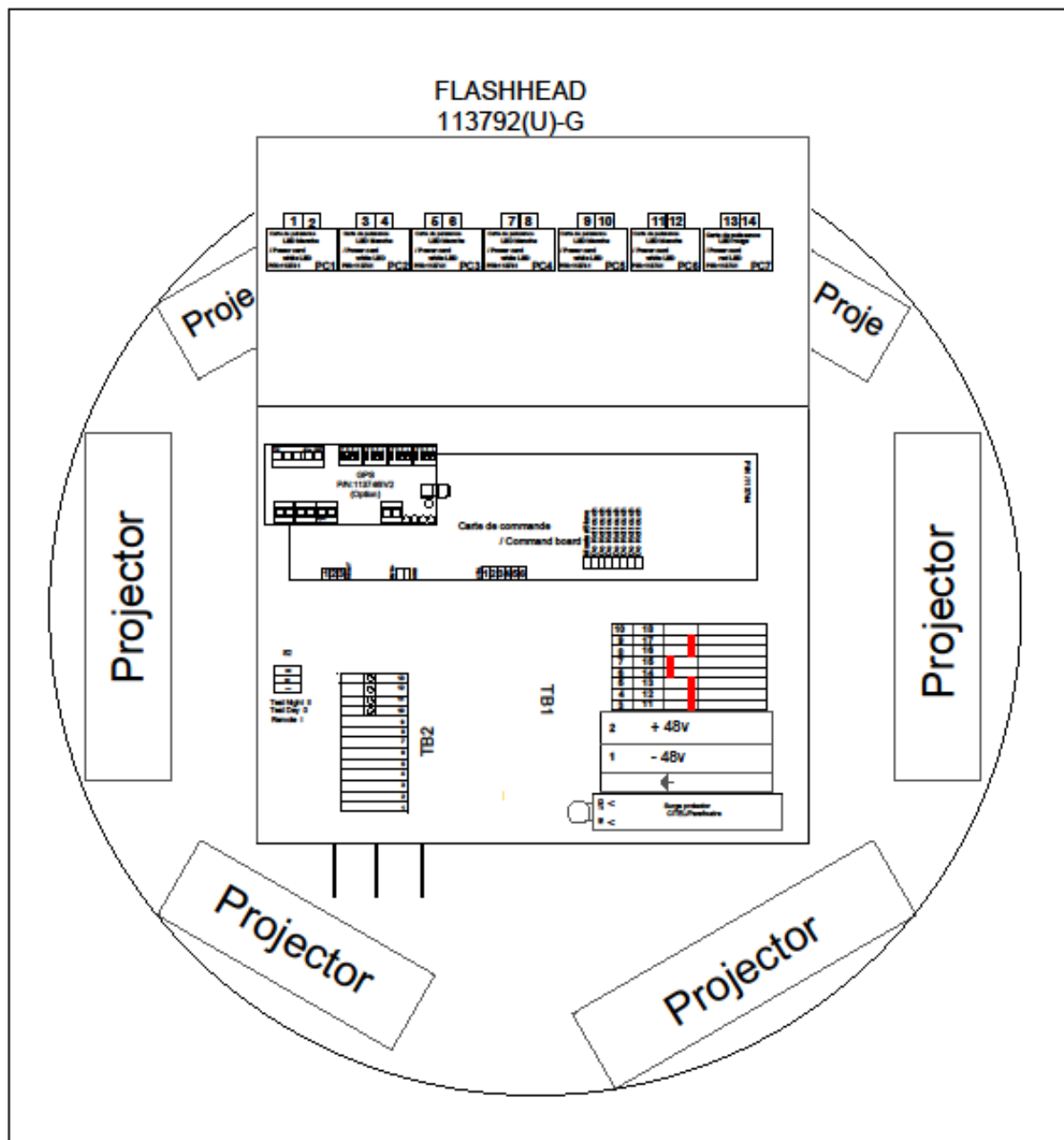

Figure 1-1. FLASHHEAD COMPONENT LOCATIONS

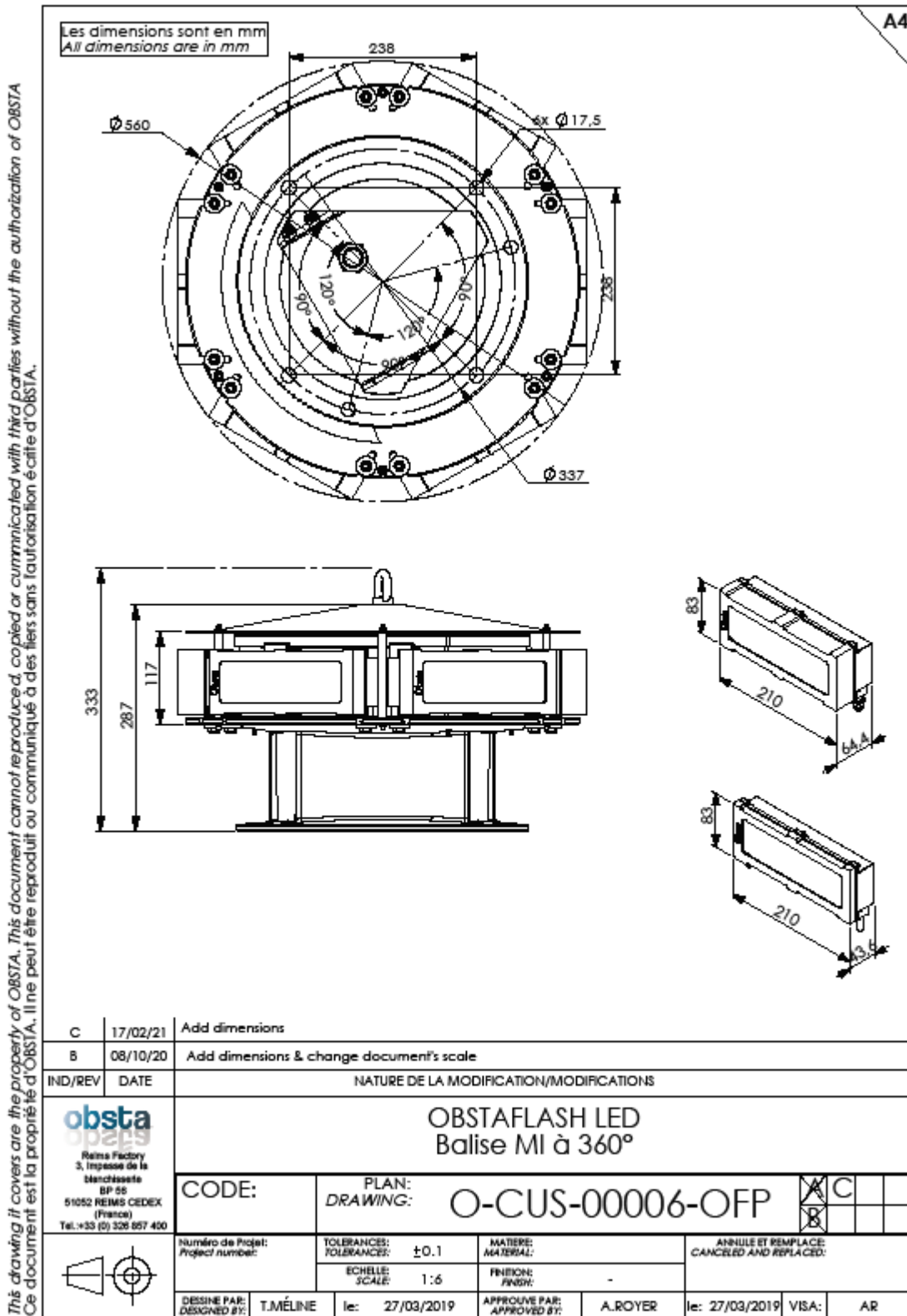

Figure 1-2. SIZE OF FLASHHEAD

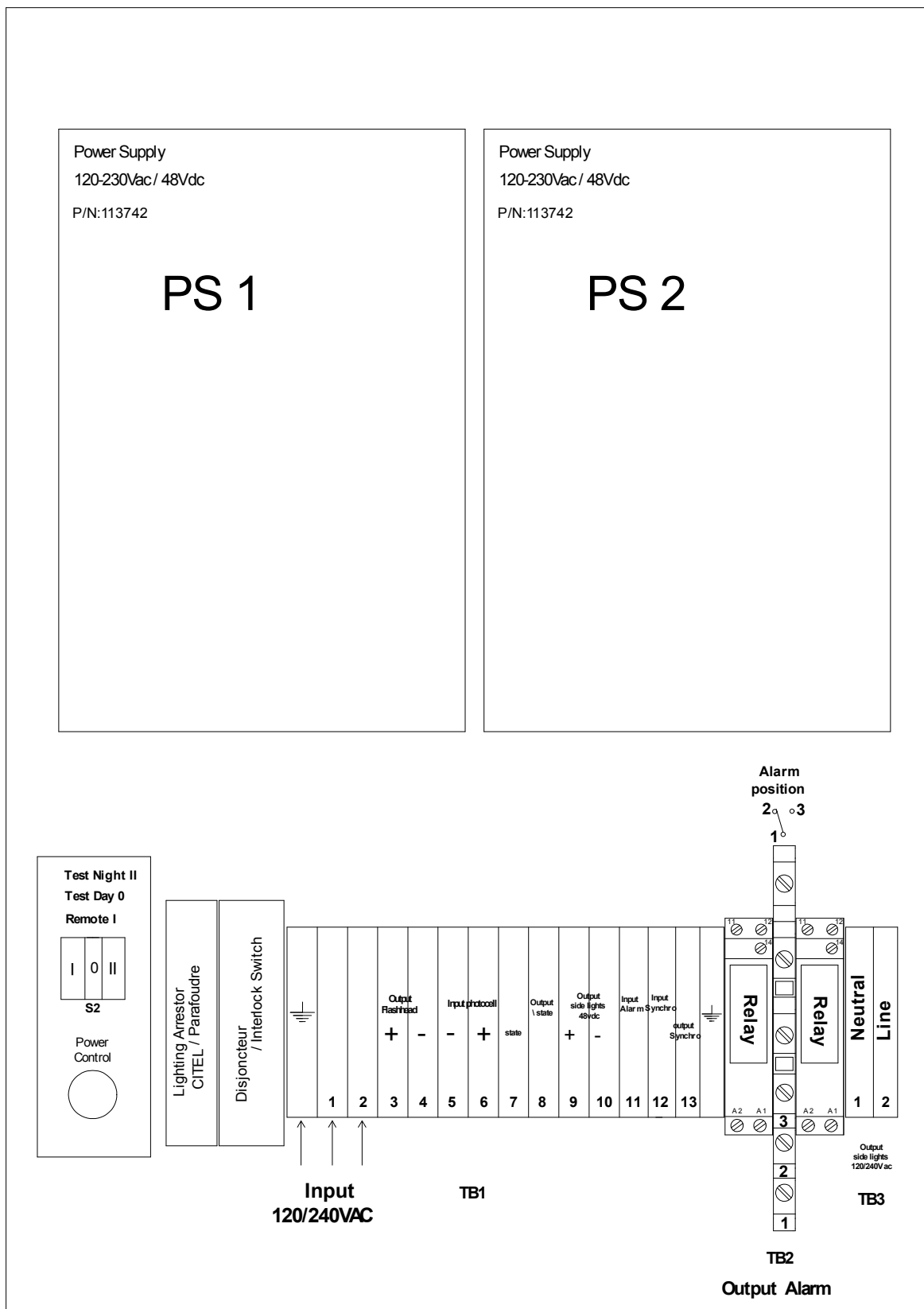

Figure 1-3. POWER CABINET COMPONENT LOCATIONS

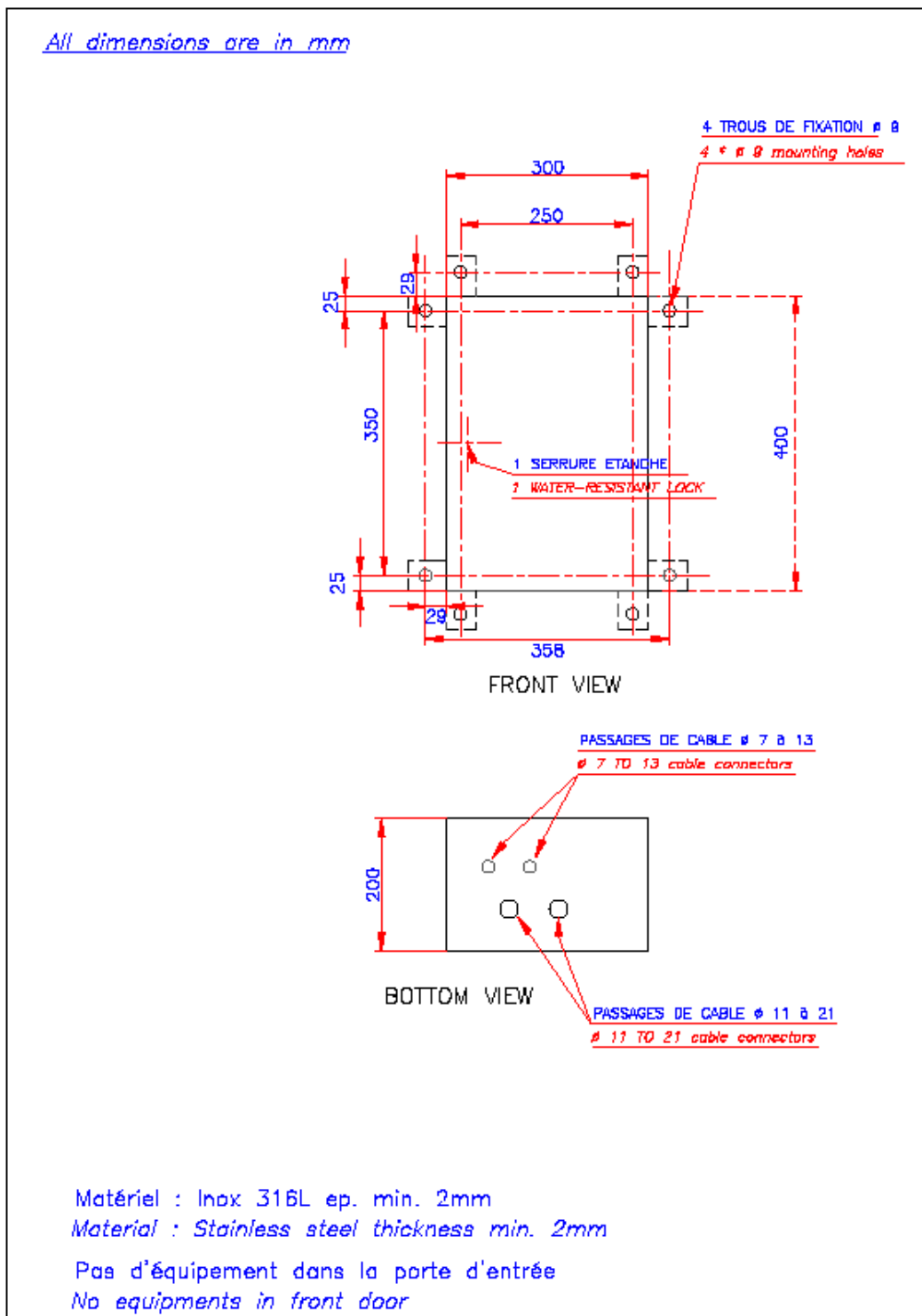

Figure 1-4. POWER CABINET ENCLOSURE P/N113797U

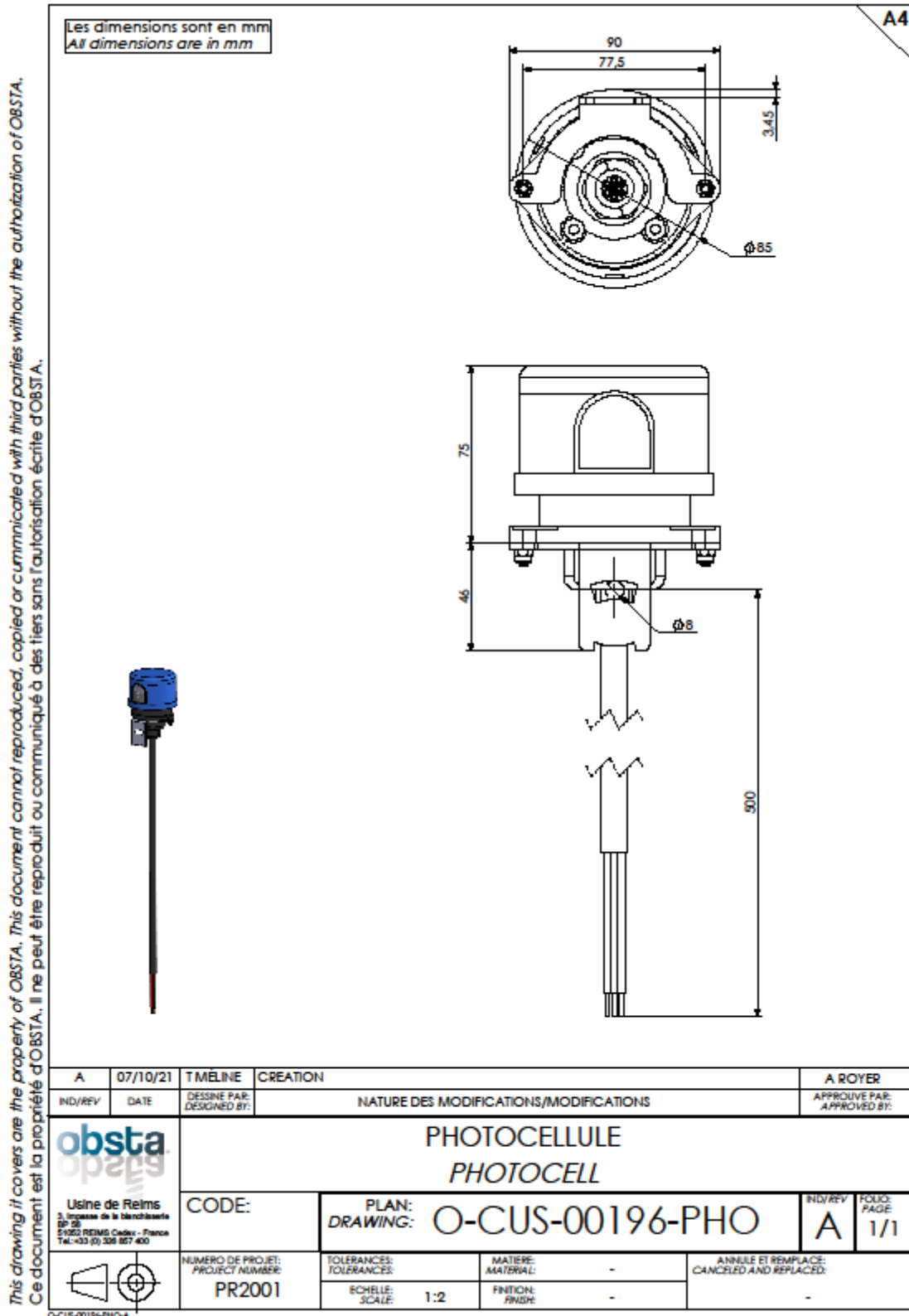

Figure 1-5. SIZE OF PHOTOCELL

1.3 Specifications

1.3.1 Light output

White day	20.000 ± 25% effective candelas in a single flash in 100ms
Red or white night	2.000 ± 25% effective in a single flash in 200ms
Beam Pattern	360° horizontally; 3°min vertically
Flash rate	40 flashes per minute in white 30 flashes per minute in red
Master/slave configuration	slaves lights can be synchronized with 1 master light and one photocell and 3x1,5mm ² shielded cable

1.3.1 Electrical input for 48VDC flash-heads

Input voltage	48 V +15%/-5%
Max current:	
White mode (P/N113792U & P/N113791U)	14A (day mode), 1,2A (night mode)
Red mode (P/N113792U & P/N113790)	1,2A

1.3.2 Electrical input for flash-heads with power cabinet

Input voltage	110VAC-230VAC ±10%
Max current:	
White mode (P/N113725UI & P/N113723UI)	8A (day mode), 0,5A (night mode)
Red mode (P/N113725UI & P/N113724I)	0,7A

1.3.3 Mechanical properties

1.3.3.1 flash-head

Weight	22 kg
Size	Diameter : 500 mm height : 333 mm
Surface area	870cm ²
Wind load	35kg at 240km/h

1.3.3.2 Power supply

Weight	12 kg
Size	w = 300 mm x h = 400 mm x d = 200 mm

1.3.4 Operating environment

Operating temperature	-40°C to +55°C
Humidity	95% relative humidity

1.3.5 System *operating* status environment

On the command card inside flash-head	10 luminous indicators as per figure 3-1
Fault indication	Relay closure, contact rating 3A at 120 V/50Hz

Section 2 : Installation

2.1 Unpacking

Carefully unpack each item and remove any internal packing material from the power supply and the OSBTAFLASH. Examine each item for obvious physical damage. Immediately report any claims to the carrier. Installation drawings is included in the power supply carton.

2.2 Mounting and preparation

2.2.1 obstafash beacon

The OBSTAFLASH is usually mounted at the highest point on the structure on a horizontal platform, or as per requirements of the local Aviation Regulation authority in place at the installation location.

We recommend that the metallic base of the flash-head to be connected through a grounding kit to the local grounding of the tower.

2.2.2 Wiring of the flash-head (figure 2-1)

- Open the cover and the stainless power supply of the flash-head,



- Insert the cable through the cable entry below the flash-head; Once the cable is firmly attached, connect the 48VDC wires to the terminal TB1 number 1 (-) and 2(+) and the grounding and/or shield on the yellow terminal of TB1.



If the flash-head is provided with an OBSTA power cabinet P/N113797U, the cross section of the power cable must be:

For dual color or white only obstafash systems P/N 113725UI, 113723UI, 113758U, 113757U			
Cable length	1-50m (1-160ft)	50-100m (160-300ft)	100-150m (300-500ft)
Cable diameter	2,5mm ² (14awg)	5mm ² (12awg)	7,5mm ² (10awg)
For red only obstafash systems P/N 113724I, 113756U			
Cable length	1-150m (1-500ft)		
Cable diameter	1,5mm ² (16awg)		

○ Between flash-head and obsta cabinet, 1 to 3 control wires have to be connected inside the flash-head (or as per drawing provided by OBSTA) for external day/night signal, optional synchronization and alarm signal sent down to cabinet:

- For L-865/L-864 or L-865 flash-heads, connect the day/night wire (48V=night mode, 0V=day mode) on the terminal TB1 number 7



- If the flash-head in slave mode must synchronize with other ones, connect the top sync (24-48Vdc pulse coming from GPS interface or a master light) on the terminal TB1 number 4



- Connect the alarm cable (48V=OK, 0V=alarm) on the terminal TB1 number 10



2.2.3 Ambient Light Sensor P/N100757 (photocell)

If included, the ambient light sensor should be mounted upright, away from artificial light (such as floodlights), and in a location that will enable its sensor window to have an unobstructed view of the polar sky (eg., pointed north in the northern hemisphere).

The photocell 48VDC returns 0V during day time and +48Vdc close in darkness

Input voltage	48VDC +15/-10%
Output voltage	48VDC +15/-10% (night time), 0V (day time)

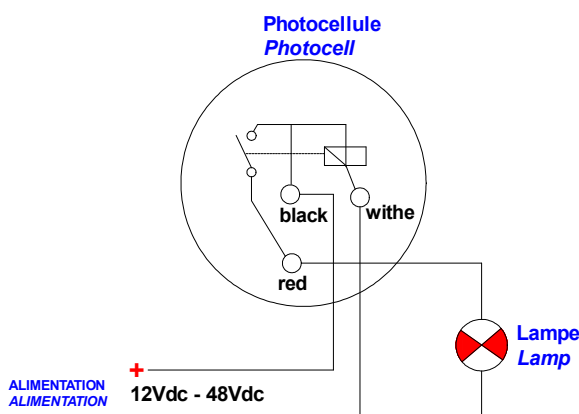

2.2.5 Synchronization by cable

One light should be configured as the master and the other as slaves (as per 3.2). The photocell should be wired on the master light only. The 2 lights (or more) should be connected together through a shielded cable 3x1,5mm² through TB1 on “Sync input/output”, “Photocell Night state” and ground position

2.3 Final check

Before power on, CHECK :	<ul style="list-style-type: none">✓ The input voltage✓ The wiring diagram
After power on, CHECK :	<ul style="list-style-type: none">✓ Flash rate✓ Synchronisation between the flash-head

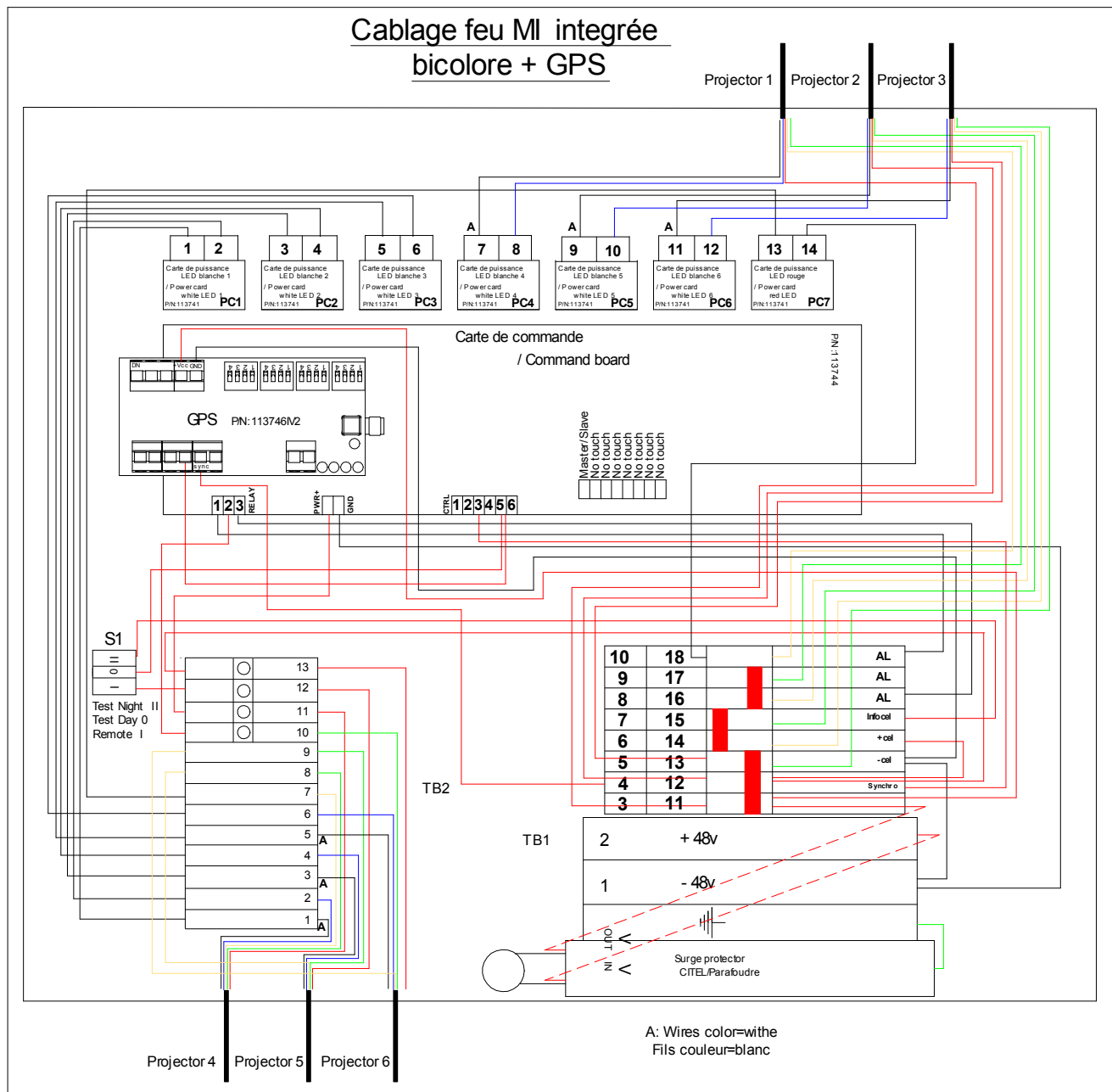

Figure 2-2. INTERNAL WIRING DIAGRAM OF flash-head P/N113792IRU + GPS P/N113746IV2

Cablage alimentation pour tête de feu intégrée FAA

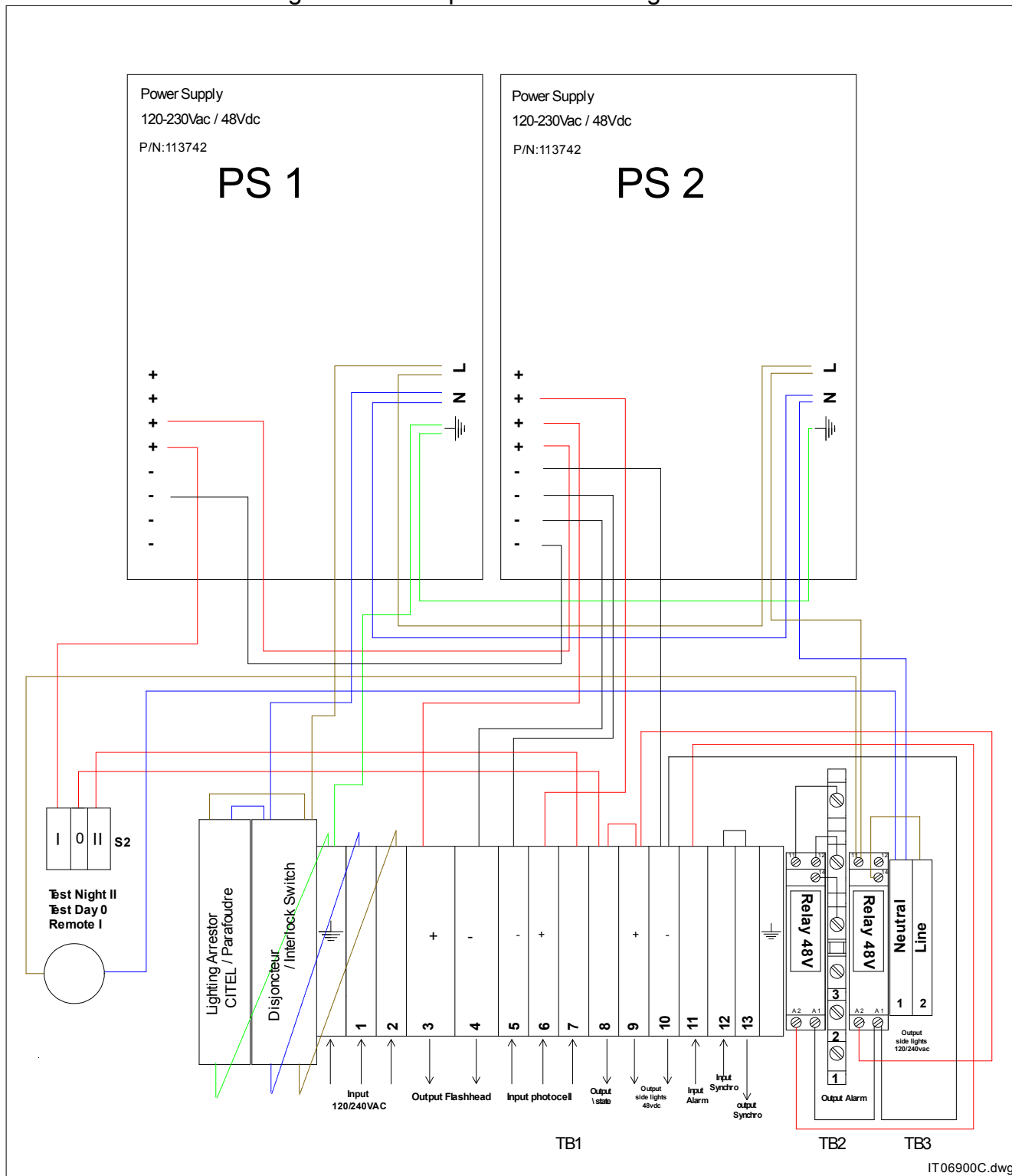

Figure 2-3. INTERNAL WIRING DIAGRAM OF POWER SUPPLY P/N113797U

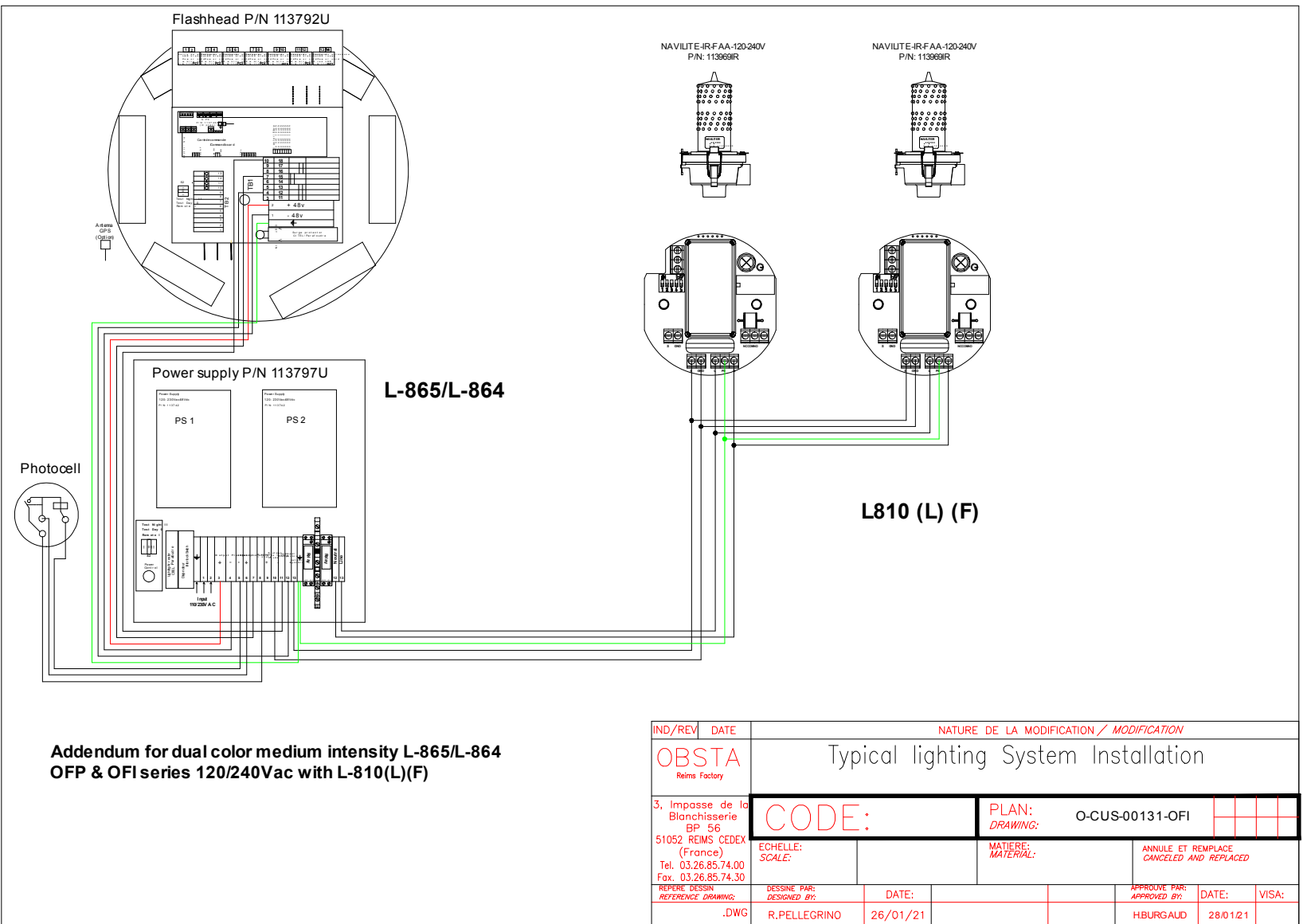

Figure 2-5. WIRING DIAGRAM OF DUAL COLOR OBSTAFASH P/N113725U

(Flash-head P/N113792U + POWER CABINET P/N113797U) + PHOTOCCELL + 1139691R

This drawing, if it varies from the property of OBSTA, is the property of OBSTA. This document cannot be reproduced, copied or communicated with third parties without the authorization of OBSTA. Ce document est la propriété d'OBSTA. Il ne peut être reproduit ou communiqué à d'autres sans son autorisation.

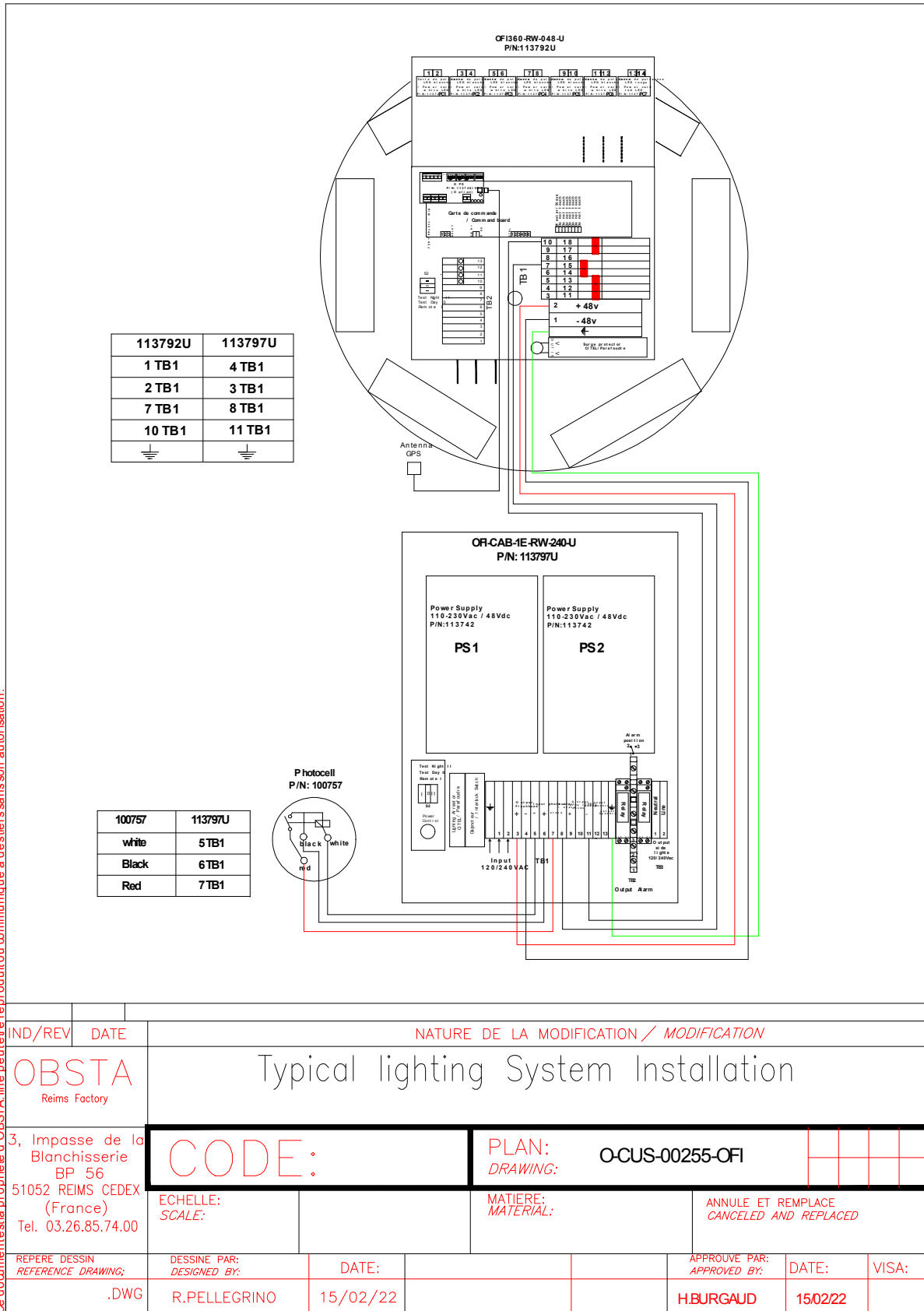

Figure 2-6. WIRING DIAGRAM OF DUAL COLOR OBSTAFASH P/N113725UI+PHOTOCELL P/N100757
 (flash-head P/N113792U + POWER CABINET P/N113797U)

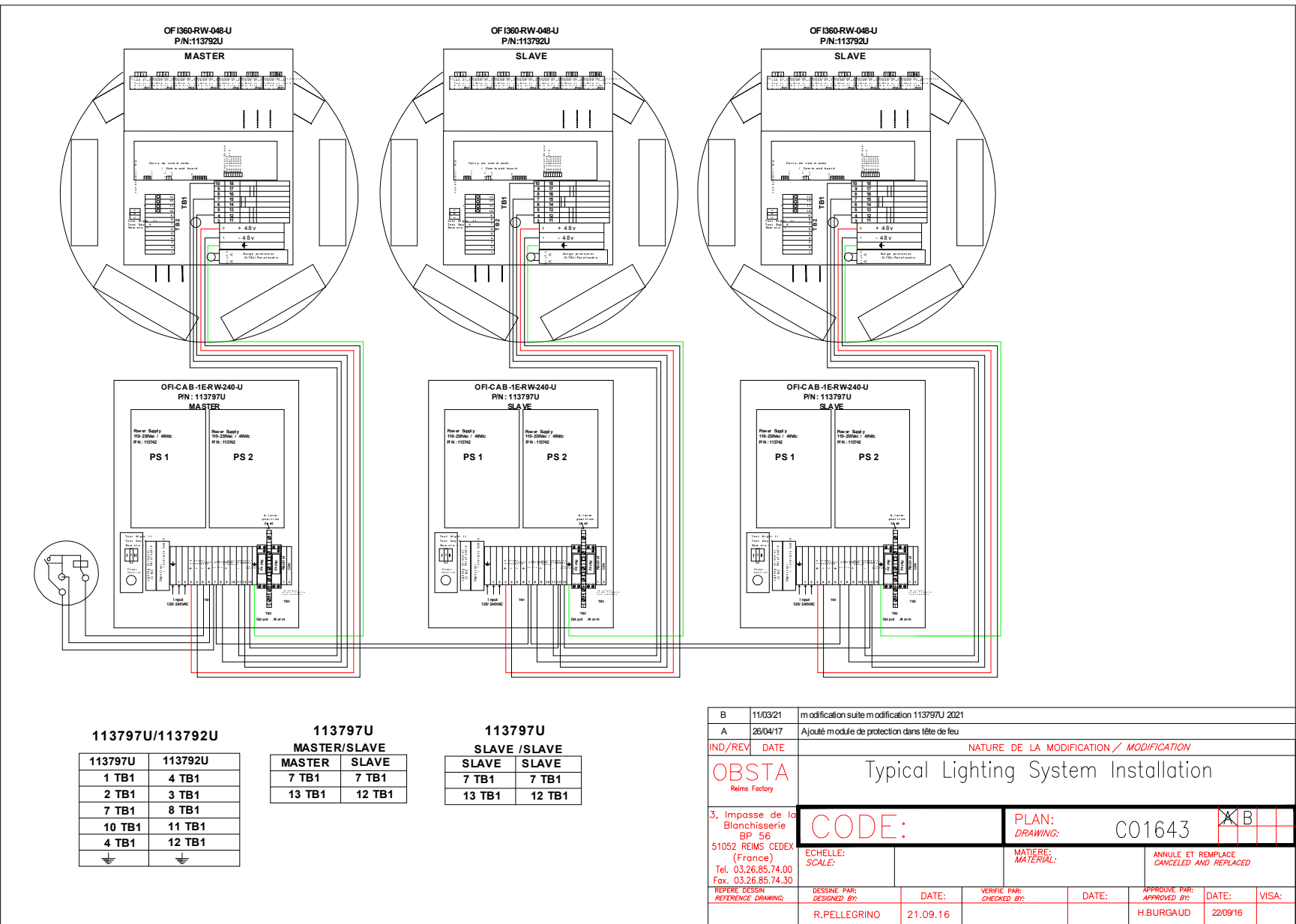

Figure 2-7. WIRING DIAGRAM OF 4 flash-head P/N113725UI + PHOTOCELL 1100755

Section 3 : Principles of operation

The flash-head is powered in 48VDC+15%/-10% from an obsta power supply or any external DC power supply providing sufficient power for the light.

3.1 Power cards

The power cards regulate the current of 2 led circuits. Each power card is connected to the command card on one side and 2 negative poles of 2 led circuits. Positive poles of all led circuits are connected together

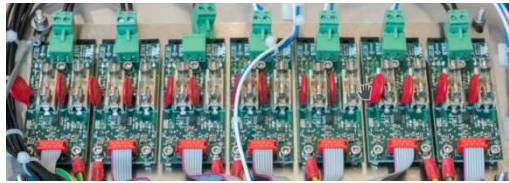

There are 6 power cards that control the current of 12 white LED circuits (negative poles are blue and white wires from each projector) and 1 power card that controls the current of 2 red led circuits (negative pole is yellow from each projector)

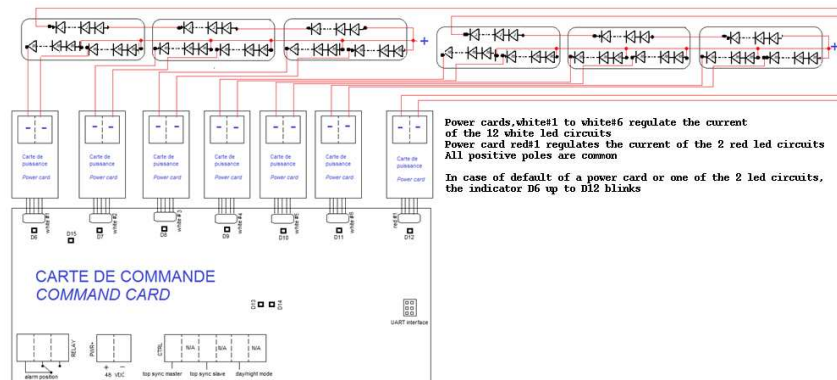

3.2 Command card

The command card is powered in 48VDC and monitors the power cards, set up the configuration of the light through dipswitch (master/slave configuration, L-865/L-864 or L-865 or L-864) and in the event of failure, send back an alarm,

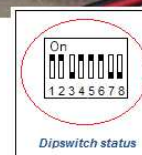
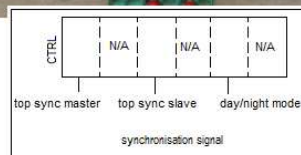
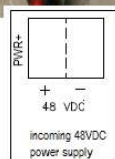
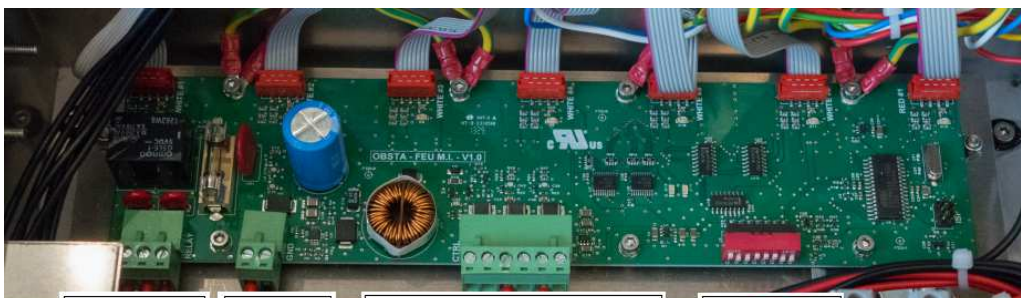

L-865/L-
 color flash-
 setting can

864 dual
 head
 be changed

through the dipswitches 4, 5 and 6 from dual color to white only or red only

(*)	4	5	6	
Position / Setting 4, 5 & 6	on	on	on	Dual mode white during day and red during night
	on	off	off	White mode day and night
	off	on	on	Red mode at night only

D6 to D15 luminous indicators on the command card:

- D6 à D12 close to WHITE#1 to WHITE#6 & RED#1 : normally off and red blinking in case of default of power card or 1 led circuit
- D15 : normally green, off in case of alarm activated
- when set-up in master mode (dipswitch n°1 on « on »), the command card creates a top sync pulse indicated by D14 and that can be sent for other flash-heads from terminal 1

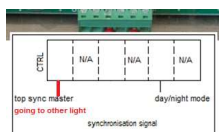

- when set-up in slave mode (dipswitch n°1 on « off »), the command card waits for a top sync pulse on terminal 3, D14 also blink at the same frequency

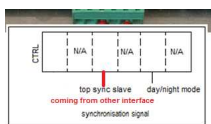

- If no pulse is received from terminal 3, D14 is off and light flashes on its own at 15 fl per minute as per D13
- Warning: In case changing master/slave dipswitch n°1 position, do not forget to change the position on the terminal connection 1 to/from 3 of the pulse wire accordingly**

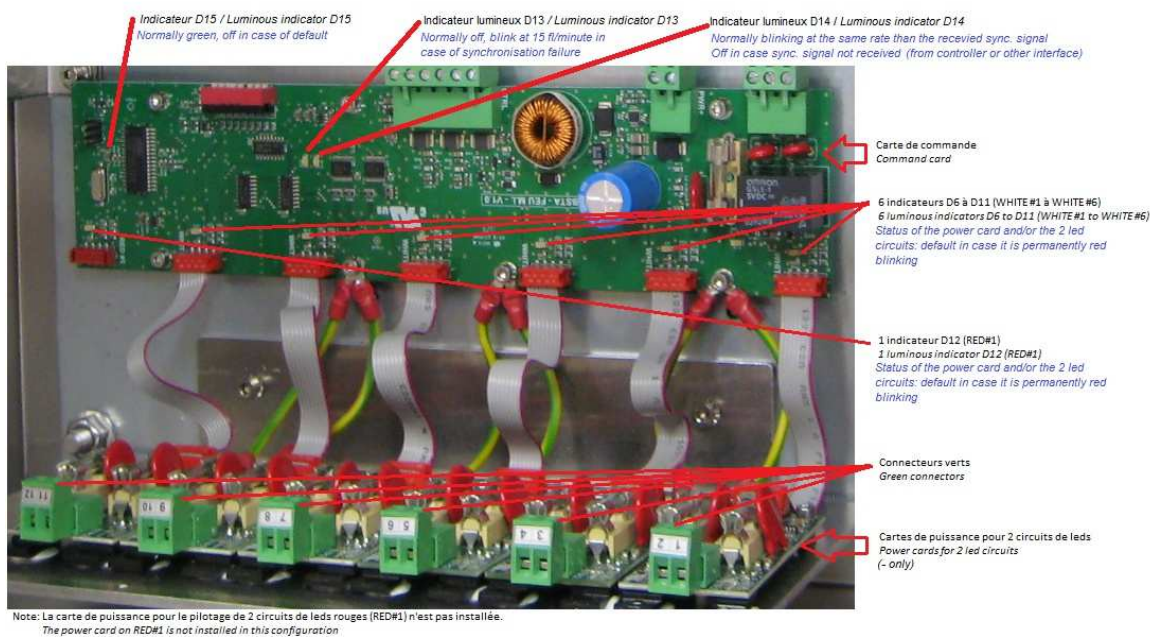

3.3 GPS P/N113746IV2 (OPTION)

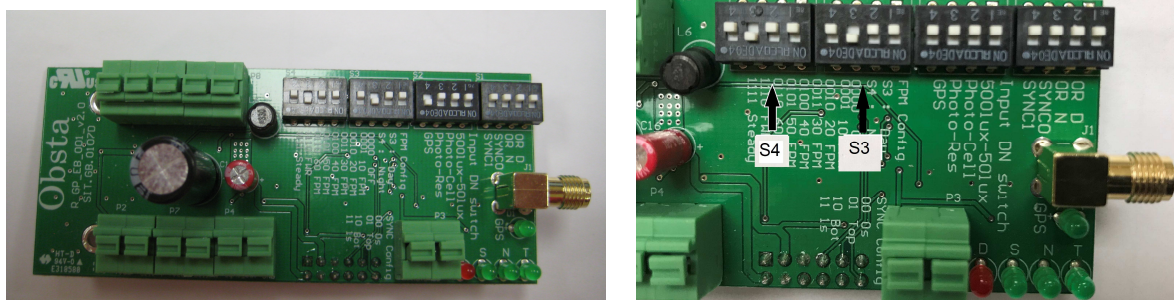

The GPS is a PCB powered in 48V and provide 2 output signals to the command card:

- one top sync (and one day/night used without photocell)

Operation :

- The green led (GPS) blinks : the GPS receive the signal
- The red led (D) and the green led (S) blinks : The GPS is not synchronized and sends a top sync to the command card at 15 flashes per minute
- The green led (S) blinks: The GPS is synchronized in day mode and sends a top sync to the command card at 40 flashes per minute (as per the S3 configuration)
- The green led (S) blinks and the leds (N) & (T) are on: The GPS is synchronized in night mode and send a top sync at 30 flashes per minute (as per the S4 configuration)

If used a day/night info (0V@day/48V@night) is sent to the command card

When the GPS is synchronized, the top sync pulse (and 0/48VDC day/night signal if used) is sent to the command card. In absence of signal received from the GPS (no satellite), no pulse is sent to the command card that flashes at 15 fl per minute (D13 blink at 15fl per minute and D14 is off).

3.4 Test button



This button force the light in day mode « Test Day » or night mode « Test Day ». It should be normally on remote position

Inside power cabinet, a voltage indicator is present

Section 4 : Maintenance - troubleshoot

4.1 Maintenance

Test	Frequency	Action	Sanction	Solution
Cable & connectors	Annual	It is recommended to check once a year the torque for each screw terminal to avoid loose wire.		
Waterproof	Annual	Visual	No water inside	Search for water leak
Corrosion	Annual	Visual	No excessive corrosion	Replace the defective parts
Photocell	Annual	Clean and mask the window of the photocell	No day/night change after 10 seconds	Change photocell
Projectors	Annual	switch S2 to « Test Day » & « Test Night »	D6 to D12 on	Replace the power card or/and associated projector as per procedure (*) below
Projectors	10 years	Replace		

4.2 Troubleshoot - malfunction

	Action	Solution
Voltage indicator is off	Check input voltage, surge protection and switch. Otherwise check DC is present on the 2 power supplies output (green indicator on it should be lighted) and/or fuse is OK	Replace the defective parts if necessary (surge protection, fuse or power supply)
The system is permanently white flashing or red	Check that S2 is on « Remote » position Otherwise masks the window of the photocell to check day/night switch and check the wiring connection from photocell to command card according to the wiring diagram	Replace photocell or command card if necessary,
Some luminous indicators D6 to D12 are blinking red in day and/or night mode	Check the wiring connection on the related power card. Otherwise check the power cards and the projector following procedure (*) below	Replace power card or/and the related projector if necessary
all indicators D6 to D11 during day time are blinking red	Check the wire cross section of the dc cable feeding the flashhead or check that your power supply is sufficient enough to feed the flashhead	Replace cable or/and power supply if necessary
D13 blinks and D14 is off, flash rate is at 15 fl per minute	Check the wiring of the GPS, the position of its antenna and its wire connection.	Replace GPS module if necessary

Contact the manufacturer if necessary

*** Procedure to test the power cards and the projectors:**

The following procedure requires not to switch off the incoming 48VDC power supply to the flashhead

Note : FAA requires that if 25% of light output is off in one azimuth, the entire light should be switch off even if some led circuits remain OK:

- So in white mode, if more than 3 white led circuits out of the 12 white led circuits is out of work, the command card normally switch off the entire flashhead
- And in red mode, if 1 out of the 2 red led circuits is out of work, the command card will also switch off the second red led circuit and switch on the white night mode (2000 candelas)

If more than 3 led circuits are out of work, the entire flashhead is off due however the 4-6 red indicators D6 to D12 still blink and almost 1-3 power card/ projector need to be changed before light turns back to on

- Default of white led circuits: one or more indicators D6, D7 D11 is/are blinking red and some projectors are not working in white

example: if luminous indicator D7 (or WHITE#2) is red blinking, disconnect the related green terminal of 2 led circuits and plug it to the next power card close to it for example D8 (or WHITE#3) that is OK:

- If the luminous indicator D8 does blink also, the projector is defective and has to be changed
- If the luminous indicator D8 does not blink, the projector is ok but the power card of WHITE#2 is defective and has to be changed

- Default of red led circuits: D12 is blinking red: 3 or 6 projectors are not working in red

- If the 6 projectors are not working in red, change the power card or use a good power card taken from one of the 6 white circuits and connect it to “red#1”). If still the 6 projectors do not work, it means that almost 2 projectors on each red led circuit are defective. It is possible to connect 2 red projectors in serial instead of 3 on the power card #red1, test all projectors 2 by 2 to identify the 2 defective ones
- If 3 projectors are not working, disconnect the defective circuit on the green connector of the power card #red1 and connect it to the second green connector of the same power card #red1: If the 3 projectors are ok, change the power card otherwise identify which projector out of the 3 projectors is not working : connect 2 projectors in serial instead of 3 until finding the defective one

Warning: never test a good led circuit on a defective power card, this can destroy the leds, always test led circuit on a good power card!!

Warning: never test a red led circuit on a power card connected to the white led circuit in day mode, the current will be too high and may destroy the red leds!!

Section 5 : SPARE PARTS

flash-head P/N113792U, 113791U, 113790U

P/N	DESIGNATION
113761UIR	PROJECTOR-RW-0.75 (dual color and white)
113760IR	PROJECTOR-R-0.75 (red only)
113744U-43J	COMMAND-CARD-48VDC-P6-RW-U (dual color configuration by default)
113741B	Power card 48V
390401	Surge protection DS230-48DC
113746IV2	GPS (option)

external power cabinet P/N113797U

113743	Security switch and test button
311621	Surge protection 120VAC (US only)
451721	Surge protection 230VAC DS215-230/G
113742	110/230Vac Power supply
100757	Photocell 48V